

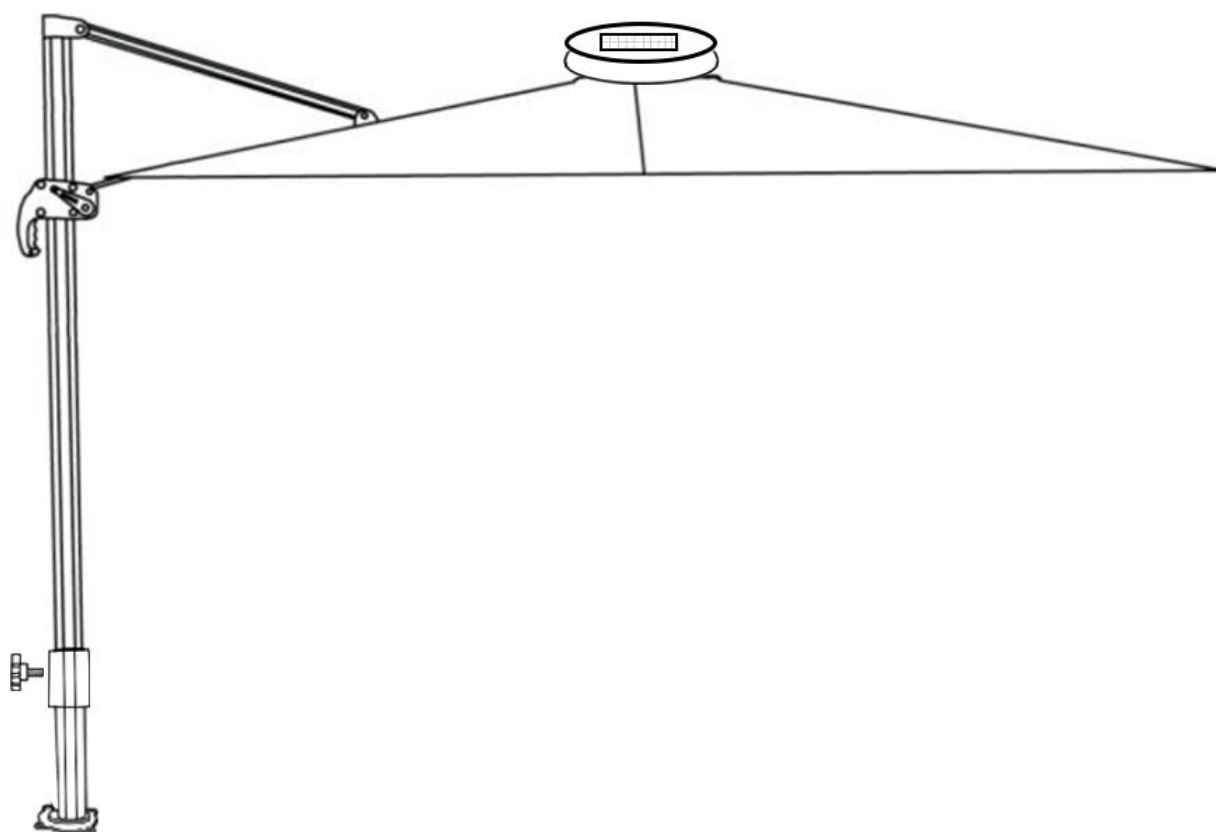







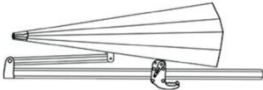

# MONTAGE ANLEITUNG

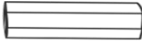

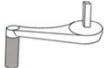
**LED Sonnenschirm**

SunLuis.S300Q.S / SunLuis.S300Q.T

**TEILELISTE**

A	B	C	D
			
Schirm	Solarpanel	Aluminiumrohr	Kunststoffrohr
1x	1x	1x	1x
E	F	G	H*
			
Fußrohr	Kurbel	Daumenschraube	Schraube M8x14mm*
1x	1x	1x	4x
I*	J*	K*	
			
Schraube M8x20mm*	Unterlegscheibe M8*	Inbusschlüssel*	
4x	8x	1x	

**Achtung:** Teile H\*, I\*, J\*, K\* sind für die Montage des optionalen Fußes.

## MONTAGEVERFAHREN

### SCHRITT 1

Bitte prüfen Sie vor der Montage den Zustand des Schirms.

1-1 Verbinden Sie das Kabel am Schirm mit dem Solarpanel (B).

1-2 Drehen Sie das Solarpanel (B) im Uhrzeigersinn auf die Oberseite des Schirms.

1-3 Entfernen Sie vor dem Gebrauch die Plastikfolie von der Oberseite des Solarpanels (B).

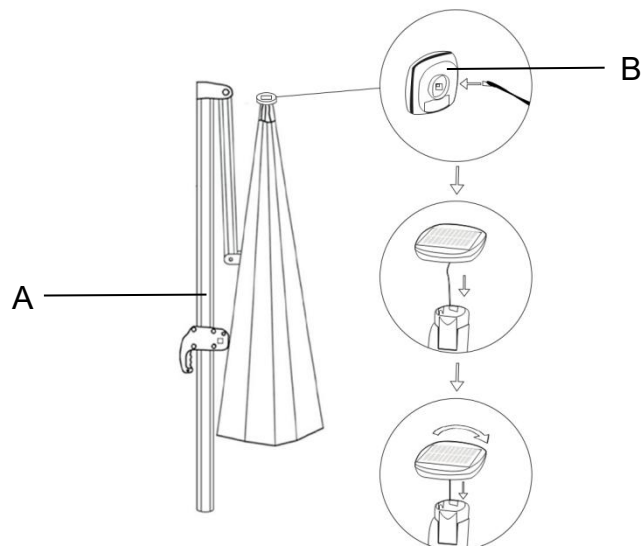

### SCHRITT 2

2-1 Führen Sie das Aluminiumrohr (C) durch das Fußrohr (E).

2-2 Führen Sie das Kunststoffrohr (D) durch das Fußrohr (E) und achten Sie darauf, dass das Schraubenloch am Kunststoffrohr (D) nach oben gerichtet ist.

2-3 Stecken Sie das Standrohr in das Fußrohr (D).

2-4 Befestigen Sie die Schraube (G) am Rohr.

2-5 Montieren Sie bitte das Fußrohr (E) auf einen kompatiblen Schirmfuß\*.

**Achtung:** Der Schirmfuß\* ist nicht im Lieferumfang enthalten.

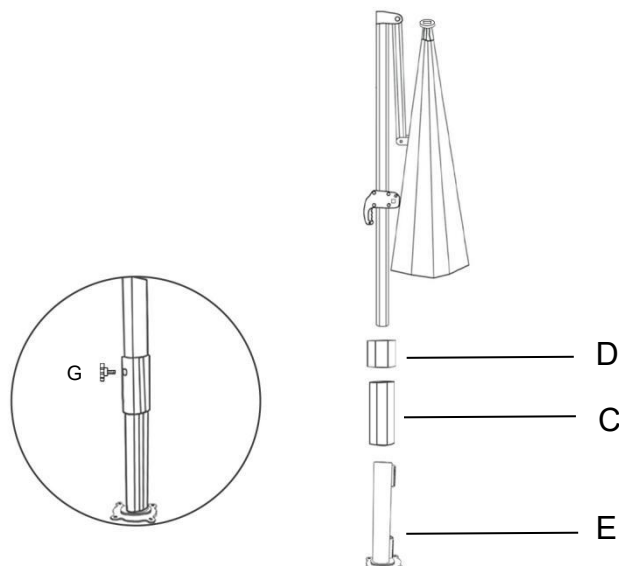



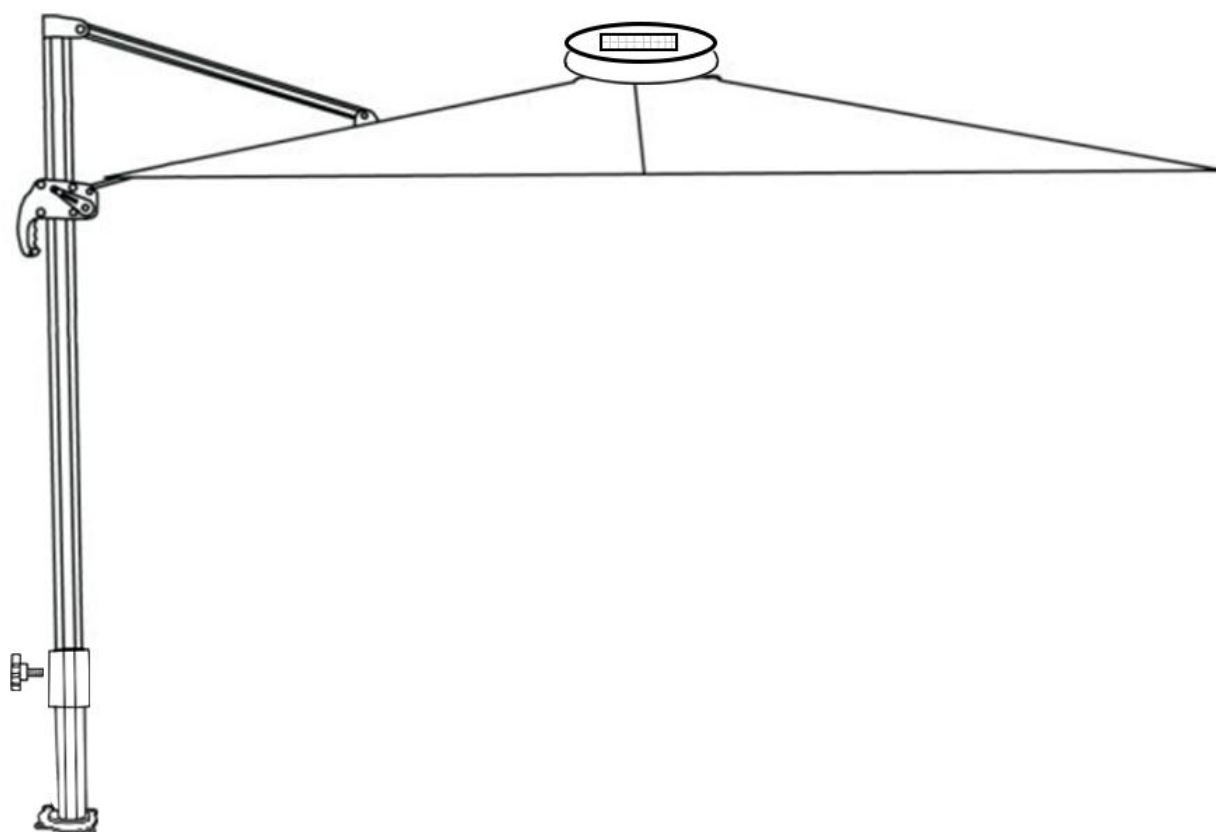





# ASSEMBLY INSTRUCTION

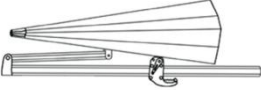

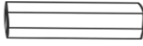
**Solar LED Umbrella**

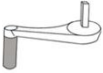
SunLuis.S300Q.S / SunLuis.S300Q.T

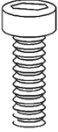
**PARTS LIST**

A	B	C	D
 <p>Umbrella body</p>	 <p>Solar panel</p>	 <p>Aluminium tube</p>	 <p>Plastic tube</p>
1x	1x	1x	1x
E	F	G	H*
 <p>Base tube</p>	 <p>Crank</p>	 <p>Thumb screw</p>	 <p>Screw M8x14mm*</p>
1x	1x	1x	4x
I*	J*	K*	
 <p>Screw M8x20mm*</p>	 <p>Washer M8*</p>	 <p>Allen Key*</p>	
4x	8x	1x	

**Attention:** Parts H\*, I\*, J\*, K\* are for mounting the optional base.

## ASSEMBLY PROCEDURES

### STEP 1

Please check the status of the umbrella before assembly.

- 1-1 Connect the cable on the umbrella to the solar panel (B).
- 1-2 Rotate the solar panel (B) clockwise to the top of the umbrella.
- 1-3 Remove the plastic film from the top of the solar panel (B) before use.

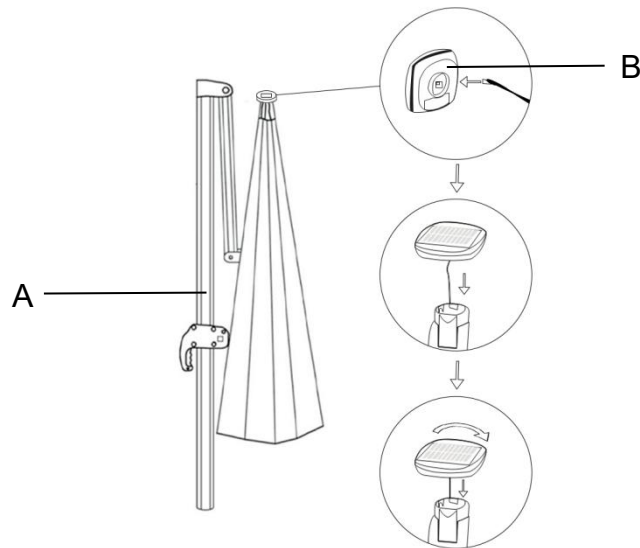

### STEP 2

- 2-1 Pass the aluminium tube (C) through the base tube (E).
- 2-2 Pass the plastic tube (D) through the base tube (E), make sure the screw hole on the plastic tube (D) is on the top.
- 2-3 Put the umbrella main pole into the base tube (D).
- 2-4 Fasten the screw (G) on the tube.
- 2-5 Please install the base tube (E) to a compatible umbrella base\*.

**Attention:** The umbrella base\* is not included in the scope of delivery.

