











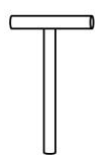

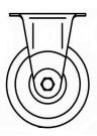

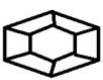
# MONTAGEANLEITUNG

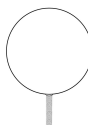
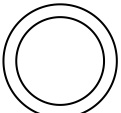
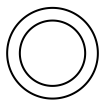
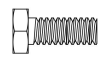
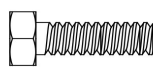
## Hilton

A	B	C	D	E
				
Gestell links	Gestell rechts	T-Gestell	Bodenplatte	Rad mit Bremse
2x	2x	2x	1x	2x
F	G	H	I	J
				
Rad ohne Bremse	Kleiderhalter	Abdeckung	Kugelhalter	Kugel
2x	1x	1x	1x	1x
K	L	M	N	O
				
Ring groß	Ring klein	Schraube M8x20mm	Schraube M10x100mm	Schraube M10x40mm
4x	2x	12x	6x	4x
P	Q	R	S	T
				
Unterlegscheibe M10x20mm	Unterlegscheibe M10x30mm	Unterlegscheibe 12x40mm	Inbusschlüssel	Schraubenschlüssel
12x	6x	4x	1x	1x

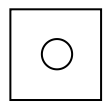
## MONTAGEVERFAHREN

1. Befestigen Sie das T-Gestell (C) am linken und rechten Gestell (A und B) mit 2 Schrauben\*.  
**ACHTUNG:** Die Schrauben\* sind am Gestell A und B vormontiert.

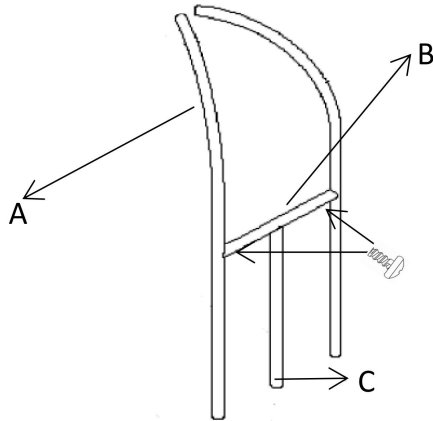

2. Befestigen Sie den Kleiderhalter (G) am Gestell (A und B) mit 4 Unterlegscheiben 12x40mm (R) und 4 Schrauben M10x40mm (O).

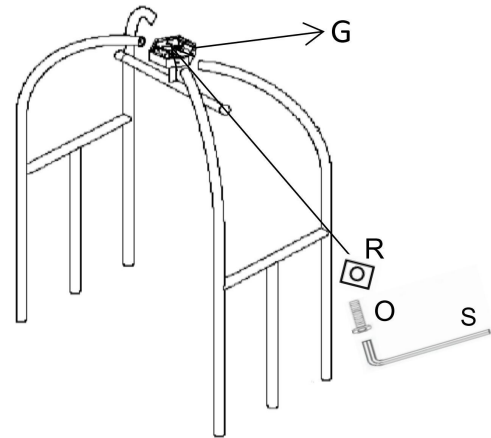

3. Befestigen Sie die Kugel (J), den Kugelhalter (I) und die Abdeckung (H) an dem Kleiderhalter (G).

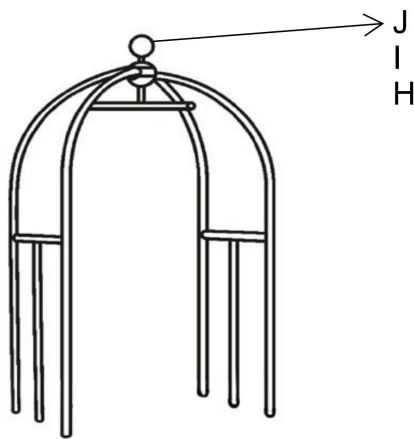

4. Befestigen Sie die Rollen (E und F) an der Unterseite der Bodenplatte (D), jede Rolle mit 3 Schrauben M8x20mm (M) und 3 Unterlegscheiben M10x20mm (P).

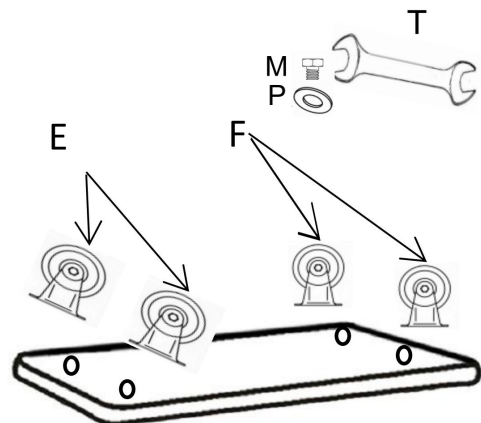

5. Befestigen Sie das gesamte Gestell an der Bodenplatte (D) mit 6 Schrauben M10x100mm (N), 6 Unterlegscheiben M10x30mm (Q), 4 großen Ringen (K) und 2 kleinen Ringen (L).

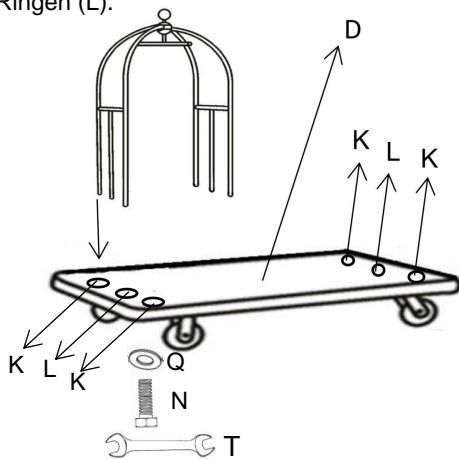



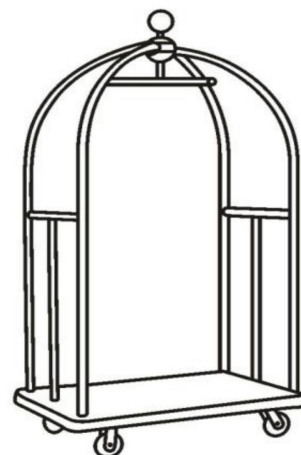







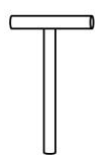



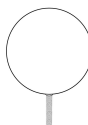
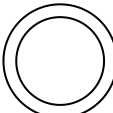
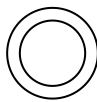

- 6.

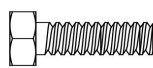

# ASSEMBLY INSTRUCTION

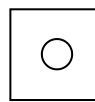
## Hilton

A	B	C	D	E
				
Frame left	Frame right	T-Frame	Base	Wheel with brake
2x	2x	2x	1x	2x
F	G	H	I	J
				
Wheel without brake	Clothes hanger	Cover	Ball holder	Ball
2x	1x	1x	1x	1x
K	L	M	N	O
				
Circle big	Circle small	Screw M8x20mm	Screw M10x100mm	Screw M10x40mm
4x	2x	12x	6x	4x
P	Q	R	S	T
				
Washer M10x20mm	Washer M10x30mm	Washer 12x40mm	Allen Key	Spanner
12x	6x	4x	1x	1x

**ASSEMBLY PROCEDURE**

1. Fix the T-frame (C) to the left and right frames (A and B) with 2 screws\*.

**ATTENTION:** The screws\* are preassembled on the frame A and B.

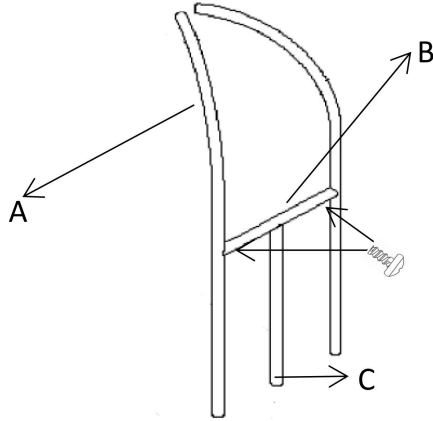

2. Fix the clothes hanger (G) to the frames (A and B) with 4 washers 12x40mm (R) and 4 screws M10x40mm (O).

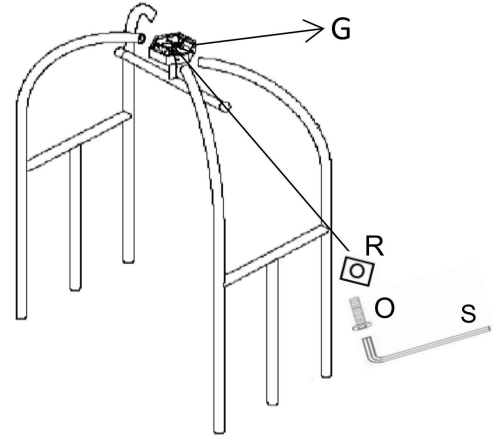

3. Fix the ball (J), ball holder (I) and cover (H) on the clothes hanger (G).

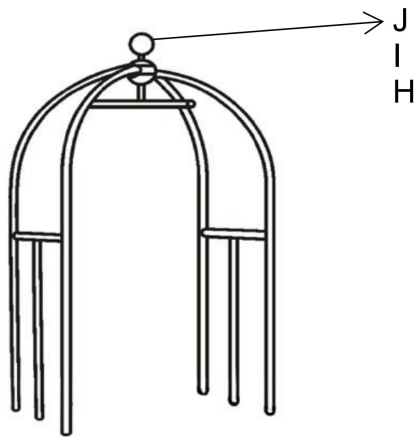

4. Fix the wheels (E and F) to the bottom of the base (D), each wheel with 3 screws M8x20mm (M) and 3 washers M10x20mm (P).

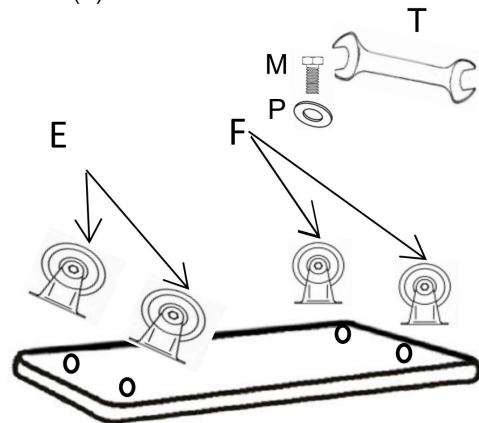

5. Fix the whole frame to the base (D) with 6 screws M10x100mm (N), 6 washers M10x30mm (Q), 4 big circles (K) and 2 small circles (L).

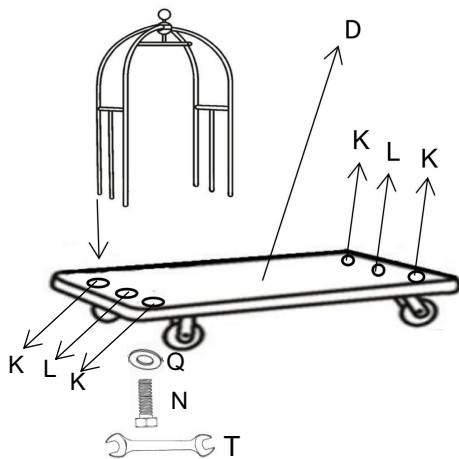

6.

